



**TOTAL SOLUTIONS PROVIDER  
GROUP**

# PRODUCT LINE UP 2024

Total Solutions Provider Group

[www.tspgmexico.com](http://www.tspgmexico.com)

D-U-N-S® Number 812916589

# PRODUCT LINE UP

2024

1.0 Machinery, Equipment & Tooling.

2.0 Manufacture and Metalwork.

3.0 Mechanical & Neumatics.

4.0 Industrial Control.

5.0 Applications.

6.0 Services

# 1.0 Machinery, Equipment & Tooling

- i. Custom made Conveyor Systems
- ii. Fastening & Part feeders
- iii. Assembly Presses
- iv. Adhesive applications
- v. Cleaning & Washing
- vi. Laser Marking
- vii. Test & Inspection
- viii. Leak Testing

# 1.0 Machinery, Equipment & Tooling

## Custom made Conveyor Systems

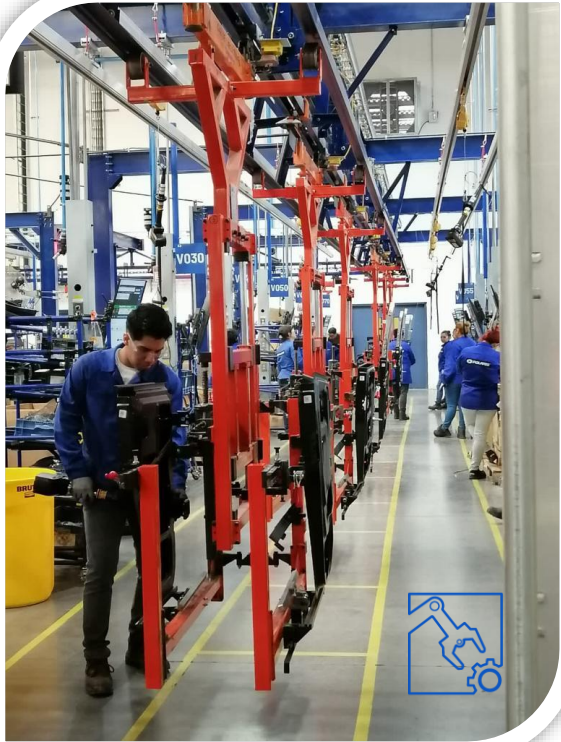

Overhead Conveyors



Chain Conveyors

Modular Belt Conveyors

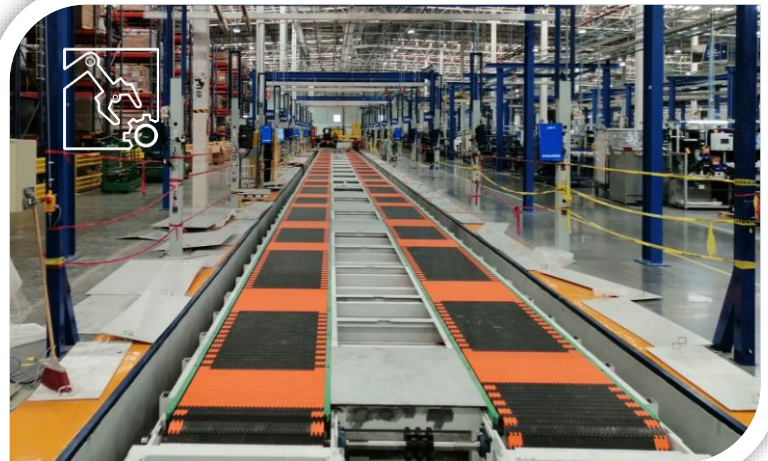

# 1.0 Machinery, Equipment & Tooling

## Fastening & Part feeders



Fastening Station with Bowl Feeder

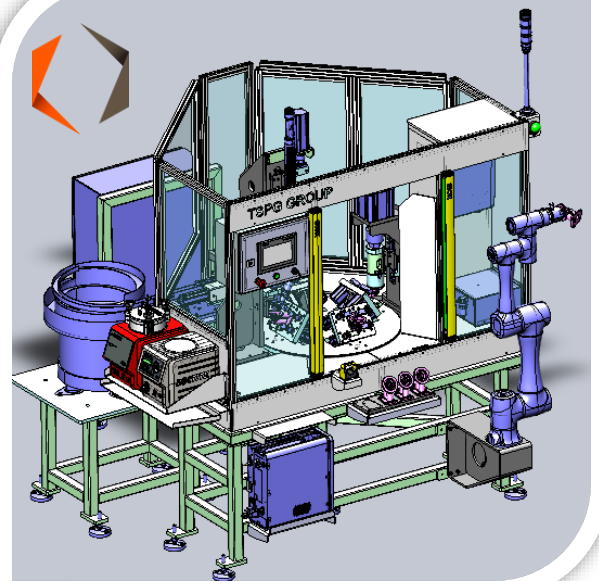

# 1.0 Machinery, Equipment & Tooling

## Assembly Presses

### Pneumatic Assembly Presses

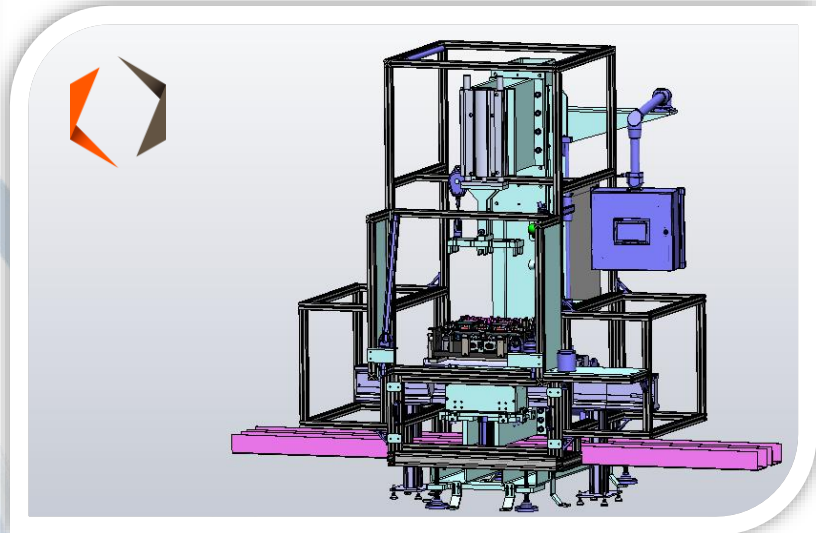
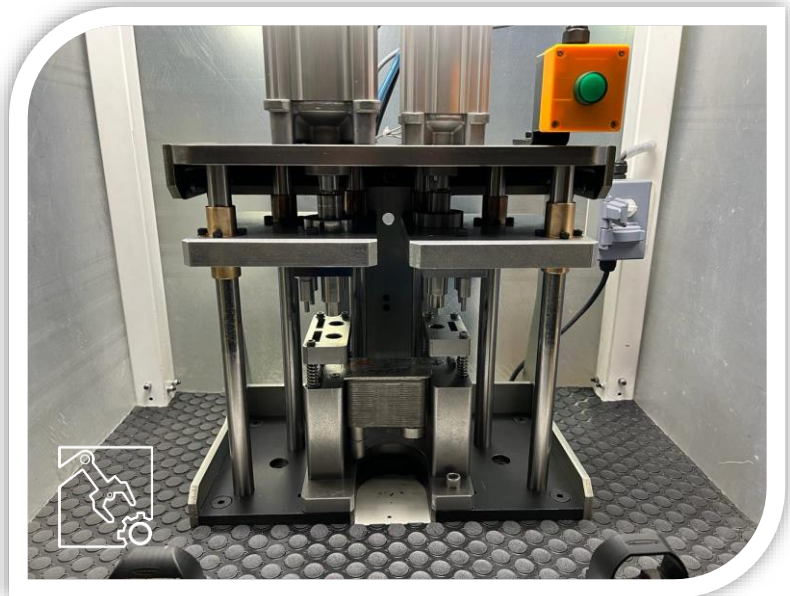

# 1.0 Machinery, Equipment & Tooling

## Adhesive Application Stations

### Loctite Adhesive Application Stations

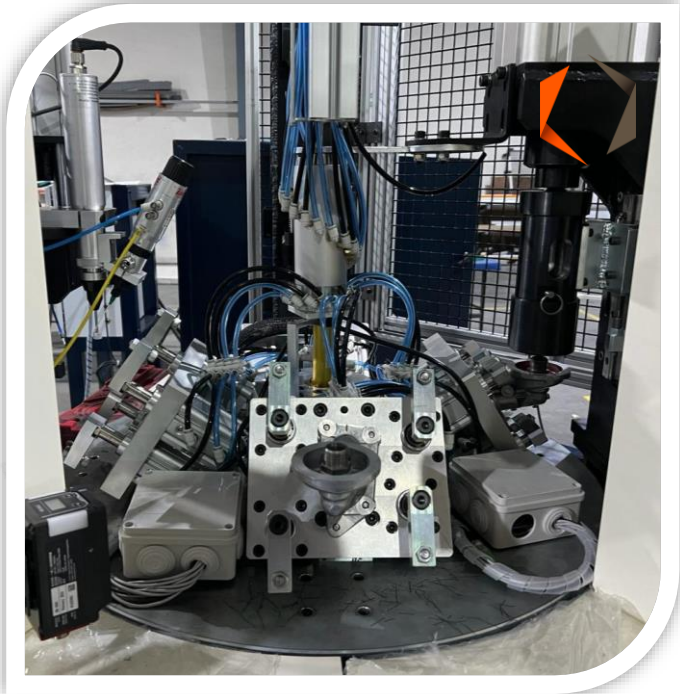

# 1.0 Machinery, Equipment & Tooling

## Cleaning Stations & Wahser Machines



Final Water boot test



Cyl Head Debur  
Robotic station





# 1.0 Machinery, Equipment & Tooling

## Laser Marking

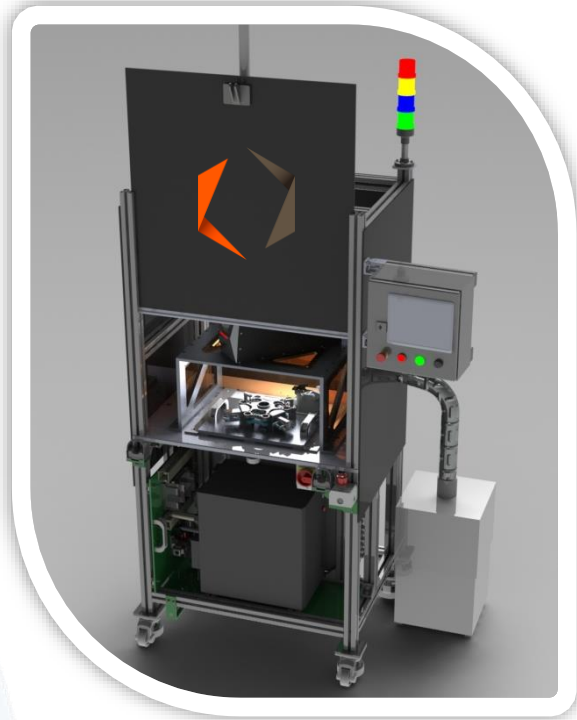
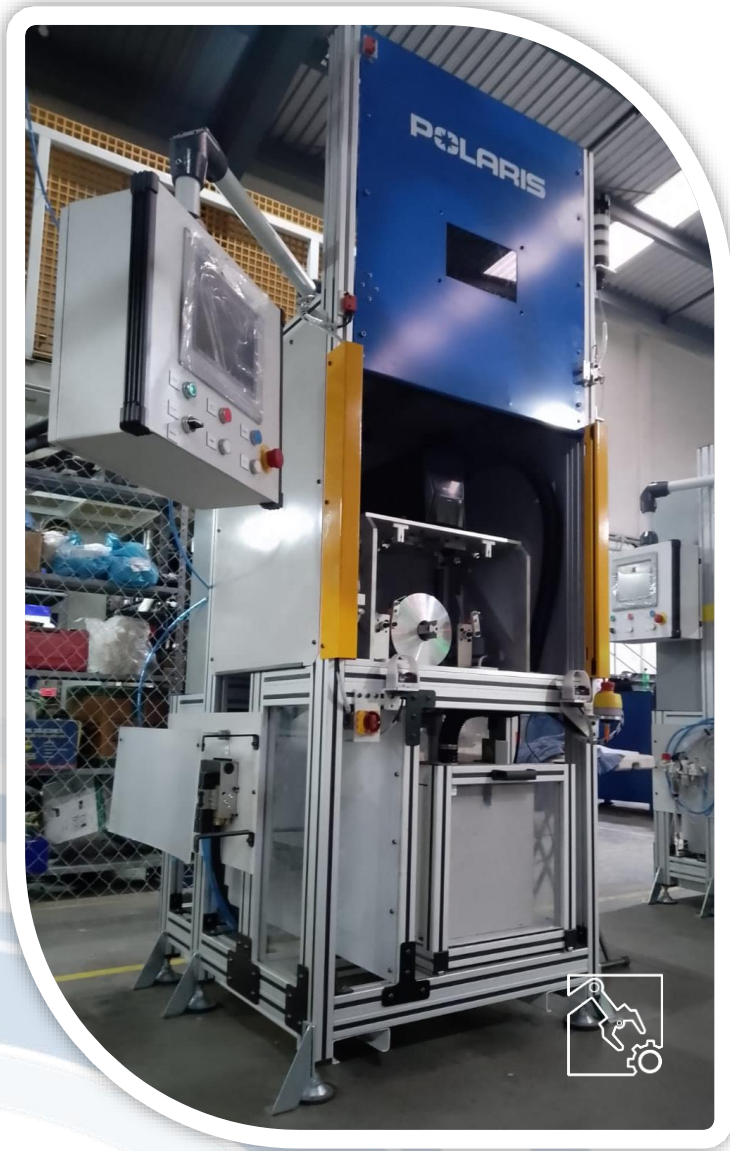

Flexible Laser Station

# 1.0 Machinery, Equipment & Tooling Test & Inspection



LVDT Stack up Station  
Functional test Stations



Marposs Cyl Head Station

Dunk Test



# 1.0 Machinery, Equipment & Tooling

## Leak Testing



Cyl Block Leak Test

Cyl Head Leak Test

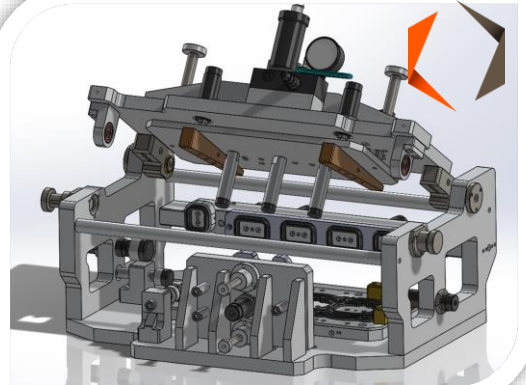
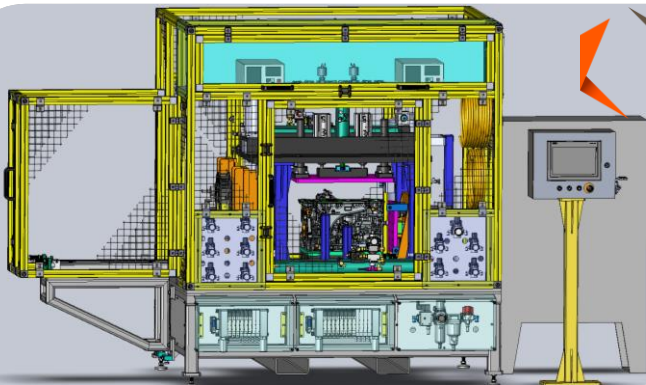

# 2.0 Manufacture and Metalwork

- i. Cut and Metalform
- ii. Machinning
- iii. Weld and Assembly
- iv. Coat and Paint
- v. Laser marking
- vi. Part inspection and certification

# 2.0 Manufacture and Metalwork

## Cut and Metal Form

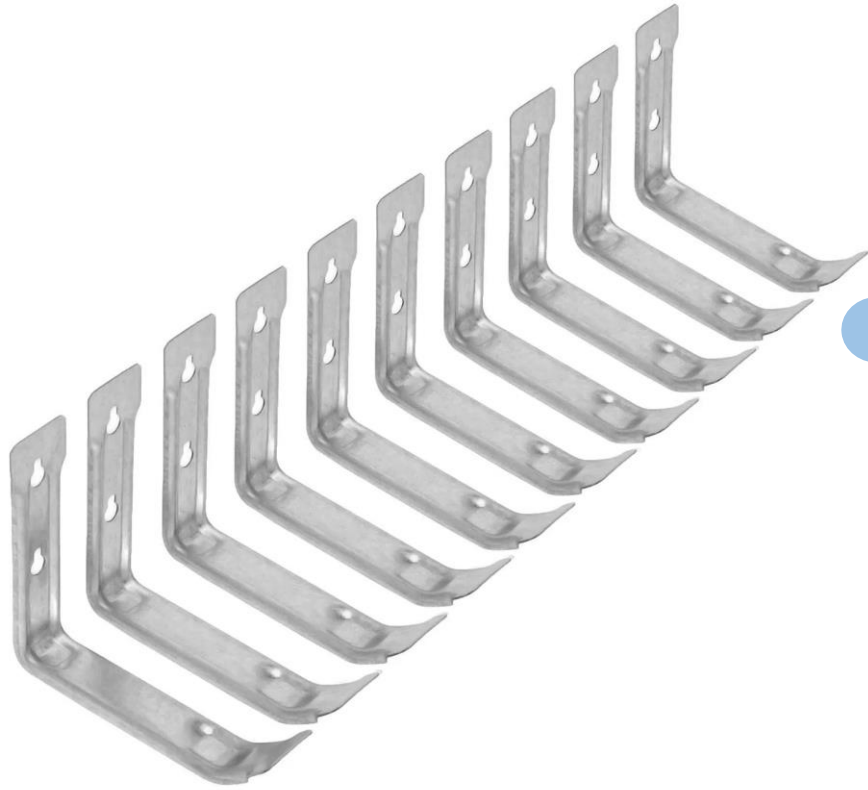

# 2.0 Manufacture and Metalwork

## Machining



# 2.0 Manufacture and Metalwork

## Weld and Assembly

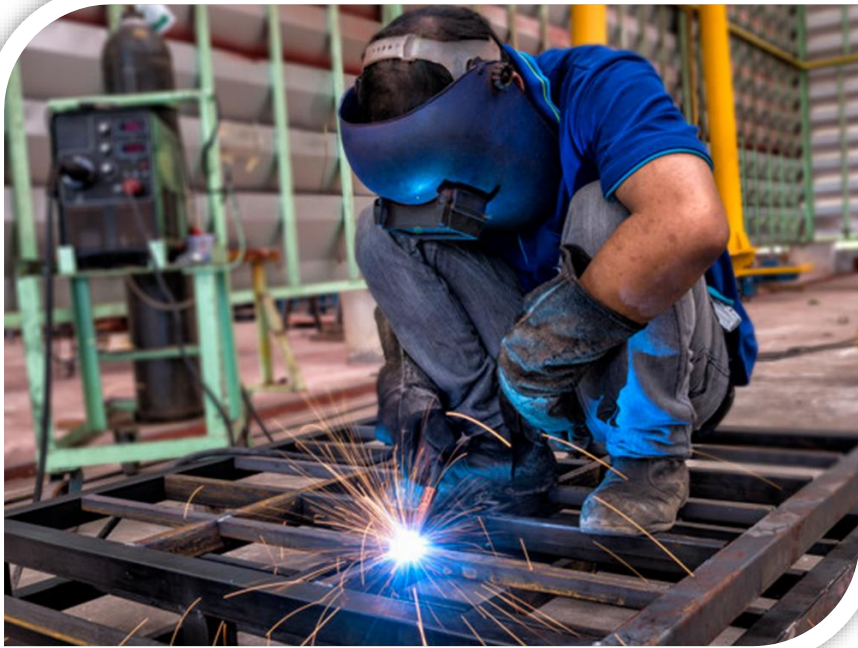

# 2.0 Manufacture and Metalwork

## Coat and Paint





# 2.0 Manufacture and Metalwork

## Laser Marking

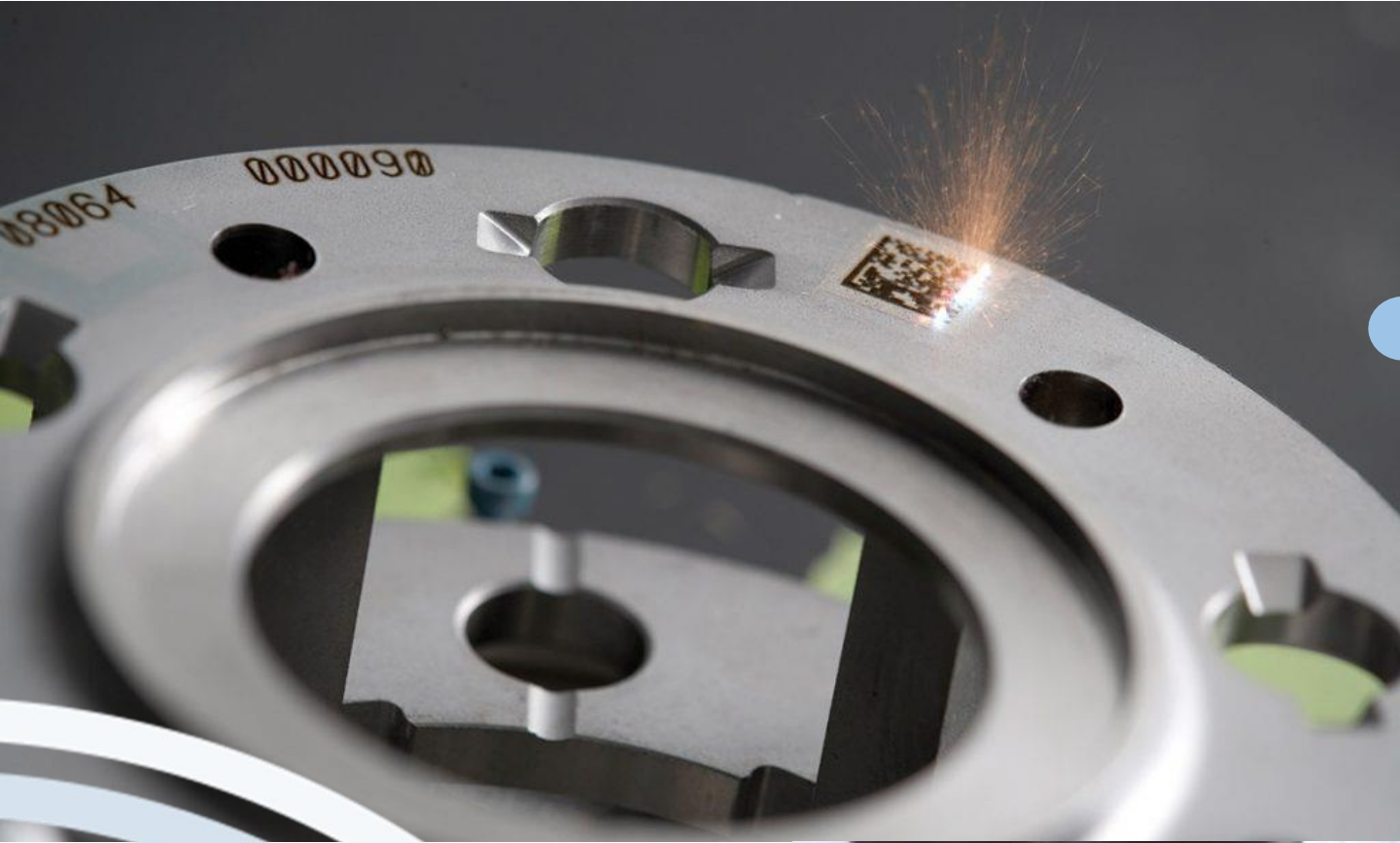

# 2.0 Manufacture and Metalwork

## Part Inspection and Certification

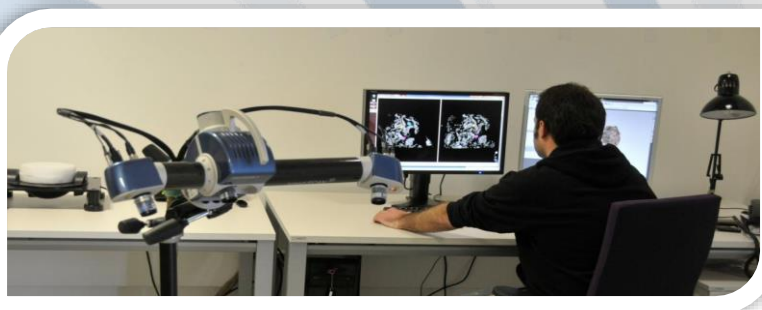

# 3.0 Mechanic and Neumatic Products

- i. Conveyor Belts and Chains
- ii. Bearings and Coupling
- iii. Springs and wire forms
- iv. Speciality Fasteners
- v. Sealing solutions
- vi. Neumatic cylinders
- vii. Aluminum profile and accesories

# 3.0 Mechanic and Neumatic Products

## Conveyor Belts and Chains



**AM MEGA**

**hellomoov**  
/ TRANSEPT

**REXNORD**

**Frost Inc.**

**SUMITOMO**

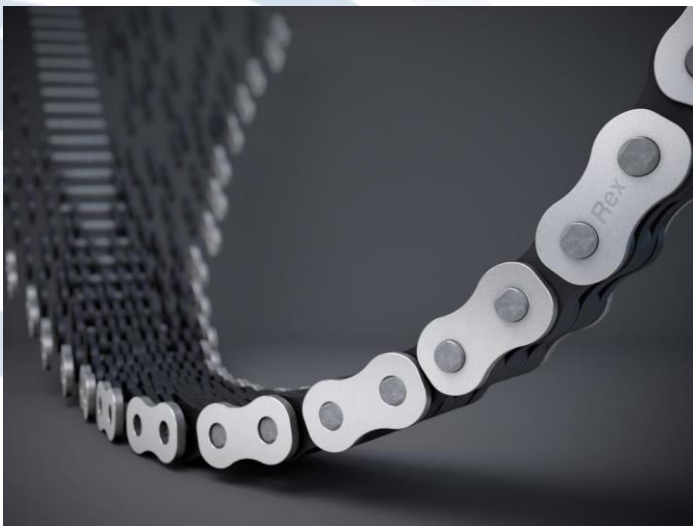

# 3.0 Mechanic and Neumatic Products

## Bearings and Couplings

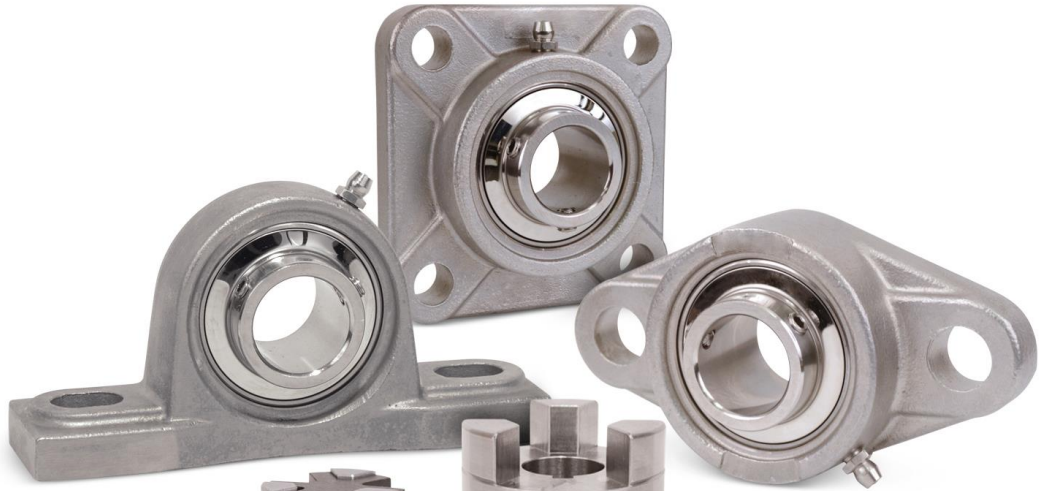



# 3.0 Mechanic and Neumatic Products

## Speciality Fasteners







# 3.0 Mechanic and Neumatic Products

## Neumatic Cylinders



# 3.0 Mechanic and Neumatic Products

## Aluminum profile and accesories

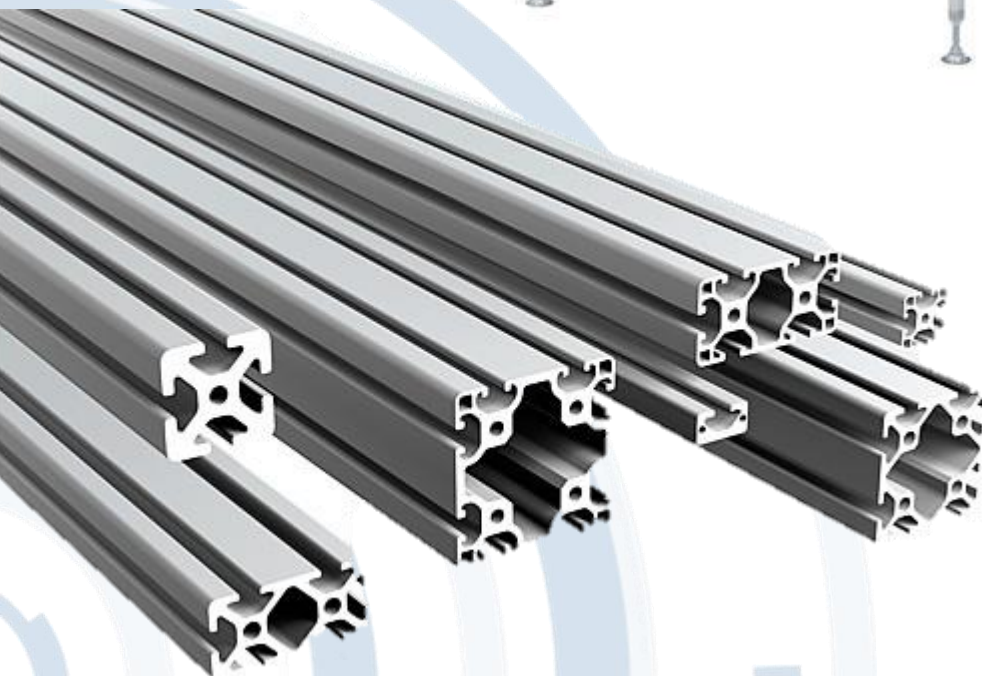

# 4.0 Industrial Controls

i. Cables and Connectors

ii. Sensors

iii. RFID

iv. Connectivity

v. Fieldbus

vi. Interface

vii. PLC & HMI

viii. IoT

# 4.0 Industrial Controls

## Cables and Connectors



# 4.0 Industrial Controls

## Industrial Sensors



**OMRON**

**KEYENCE**

**ABB**

**Rockwell  
Automation**



**PEPPERL+FUCHS**



**SIEMENS**

**TURCK**  
Your Global Automation Partner

**BANNER**  
more sensors, more solutions



**pilz**



**TOTAL SOLUTIONS PROVIDER  
GROUP**

# 4.0 Industrial Controls

## RFID



8800 RFID tags, 20 forklifts, 20 Gates

**MASS TEST**

**TURCK**

VILANT SYSTEMS

# 4.0 Industrial Controls

## Connectivity, Fieldbus & Interface

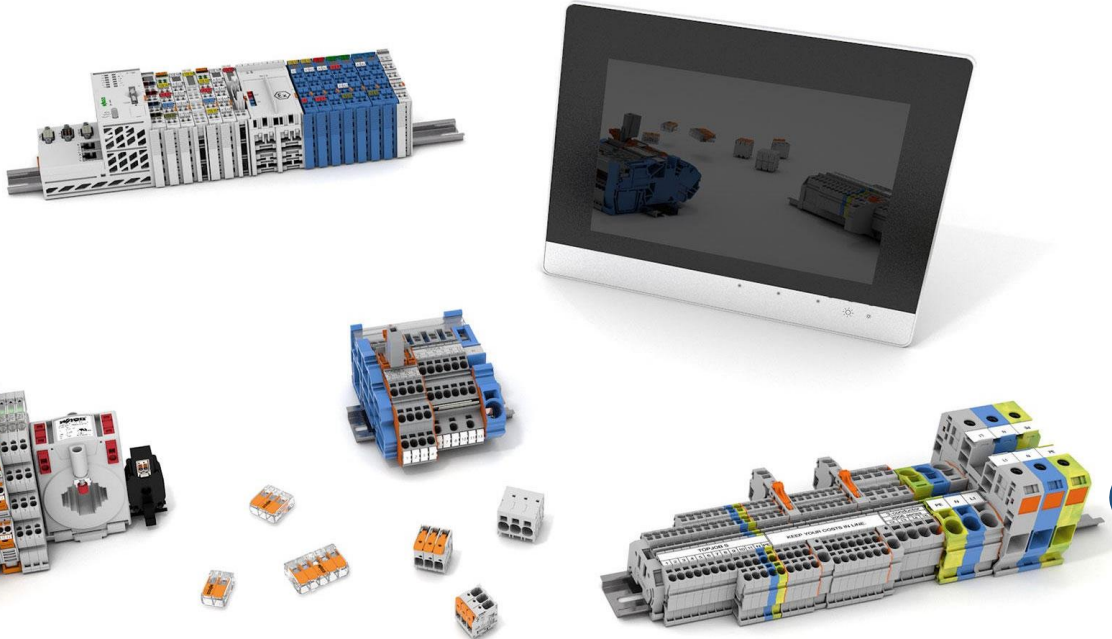

**SIEMENS**

**WAGO**<sup>®</sup>

**Rockwell  
Automation**

**TURCK**



# 4.0 Industrial Controls

## PLC & HMI



**OMRON**  
Rockwell  
Automation

**KEYENCE**

**ABB**

**SIEMENS**  
Autonics





# 4.0 Industrial Controls

IoT



# 5.0 Applications

- i. Artificial Vision
- ii. Robotics
- iii. Leak Test
- iv. Fastening
- v. Servo Press
- vi. Adhesive Dispense

# 5.0 Applications

## Artificial Vision



### Artificial Vision

Solutions to meet quality expectations with high speed and consistency.

Focused on detection for error-mistake proof, traceability, and profile-target measurement, to automate your process on a flexible and scalable solutions.

**KEYENCE** **DATALOGIC** **COGNEX**



# 5.0 Applications Robotics

## Cobots

From brand new projects, installation and production support, to rebuild, retrofit, and repair.

Our qualified staff, tools and experience, supports your critical equipment to maintain production running in optimal conditions.



**UNIVERSAL ROBOTS**

**FANUC**

**ABB**



# 5.0 Applications

## Leak Test

Our commitment is “You produce and we help you Test, the highest quality, the safest and the most reliable products to market”



Leak testing during manufacturing assembly is critical to the quality and performance of your products. It ensures parts meet not only your specifications, but your customers' expectations. We build a portfolio of machinery leak testers to address a reliable choice for manufacturing leak detection.



# 5.0 Applications

## Fastening and Torque Control



When it comes to Controlled Fastening Tools we integrate wide selection of high-quality DC nutrunners, electric and pneumatic pulse tools, tool controllers and monitors and more. We'll help you find the perfect tools to get the job done right.

Controlled Fastening Tools provide torque verification, data collection, and high-quality, productivity enhancing solutions. Get additional information on DC Nutrunners, DC Controllers, DC Controlled Accessories, Electric Pulse Tools, Pneumatic Pulse Tools, Pulse Tool Accessories, Tool Controllers and Monitors, Tool Controllers and Monitors, and Fixtured Nutrunners.



# 5.0 Applications

## Press & Servo Press

We are focused in force and torque sensing applications, giving machines the ability to “feel” how a part or product is being made.

Data is collected during these closed-loop operations, and manufacturers use that information to continually improve their processes.



**TOX**<sup>®</sup>  
PRESSOTECHNIK



**PROMESS**

**KISTLER**



# 5.0 Applications

## Adhesive Dispensing

Loctite dispense systems offers solutions for an array of adhesive package sizes for various market applications, with control and monitoring of precise amounts to ensure your process requirements.



# LOCTITE





# 6.0 Services

- i. **Electro-mechanical Service**
- ii. **Facilities Instal & Maintain**
- iii. **Repair-Rebuild-Retrofits**
- iv. **PLC & Industrial Control**
- v. **Artificial Vision**
- vi. **Robotics**

# 6.0 Services

## Electro-mechanical



From brand new projects, installation and production support, to rebuild, retrofit, and repair.

Our qualified staff, tools and experience, supports your critical equipment to maintain production running in optimal conditions

- Equipment teardown
- Equipment Installation
- Production support
- Corrective maintenance
- Machinery rebuild
- Equipment retrofit
- Preventative maintenance
- Equipment improvement

# 6.0 Services

## Facilities Installation and Maintenance

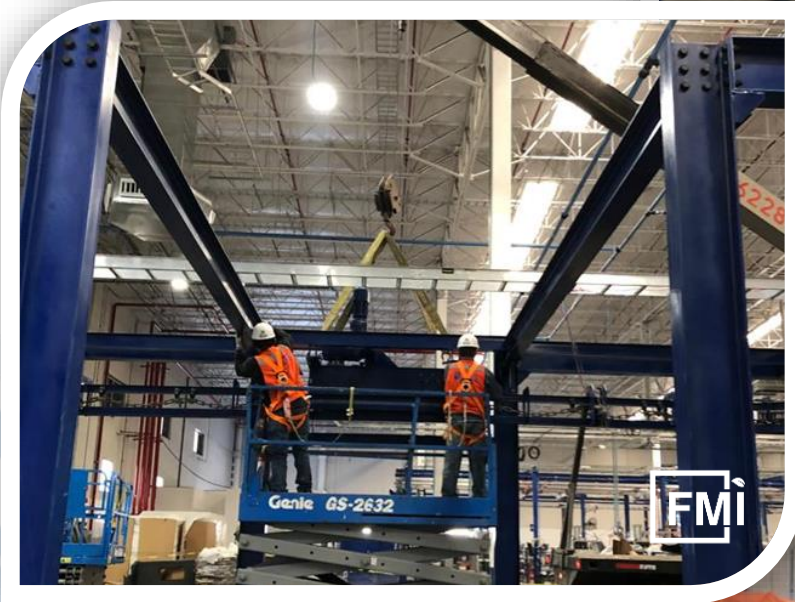
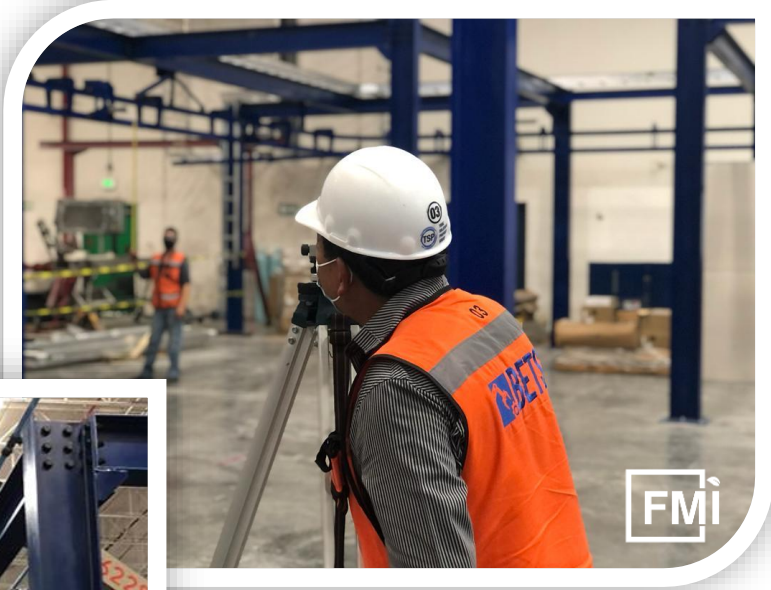

# 6.0 Services

## Repair, Rebuild and Retrofit

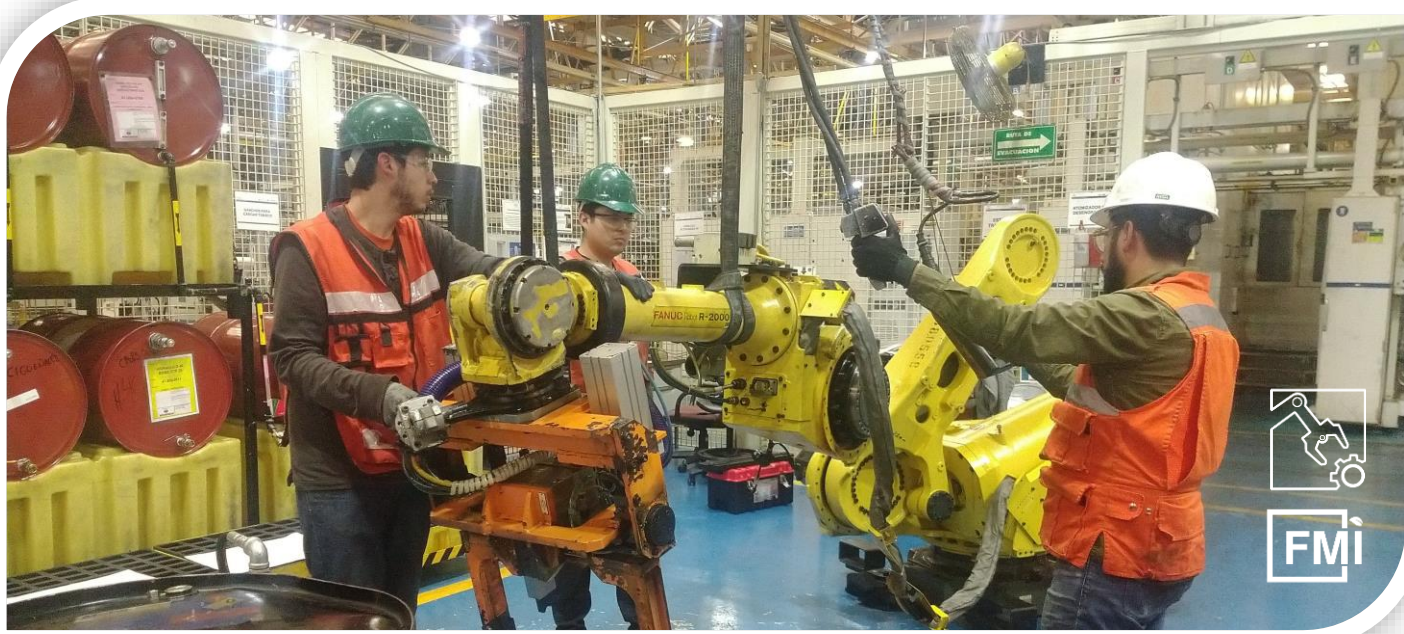

# 6.0 Services

## PLC & Industrial Control



Our staff specializes programming on several control platforms including:

Siemens	Rexroth
Allen Bradley	GE Fanuc
Mitsubishi	Telemecanique
Omron	PhoenixContact

We have the solutions for process automation and control, track and traceability, databases, RFID systems, Andon systems and production monitoring.

Let us introduce you to 4.0 industry and productivity

- PLC & HMI Programming
- Configuration and setup
- Program debug and Troubleshooting
- Updates and upgrades

# 6.0 Services

## Artificial Vision & IT Applications



We have the ideal solution for your artificial vision application, ready for 4.0 industry. We automate with the most reliable brands in the market:

- Error mistake proofing
- Inspection
- Traceability solutions
- Robotic guiding
- Measuring and gauging
- IT Network
- Industrial apps

# 6.0 Services

## Robotics

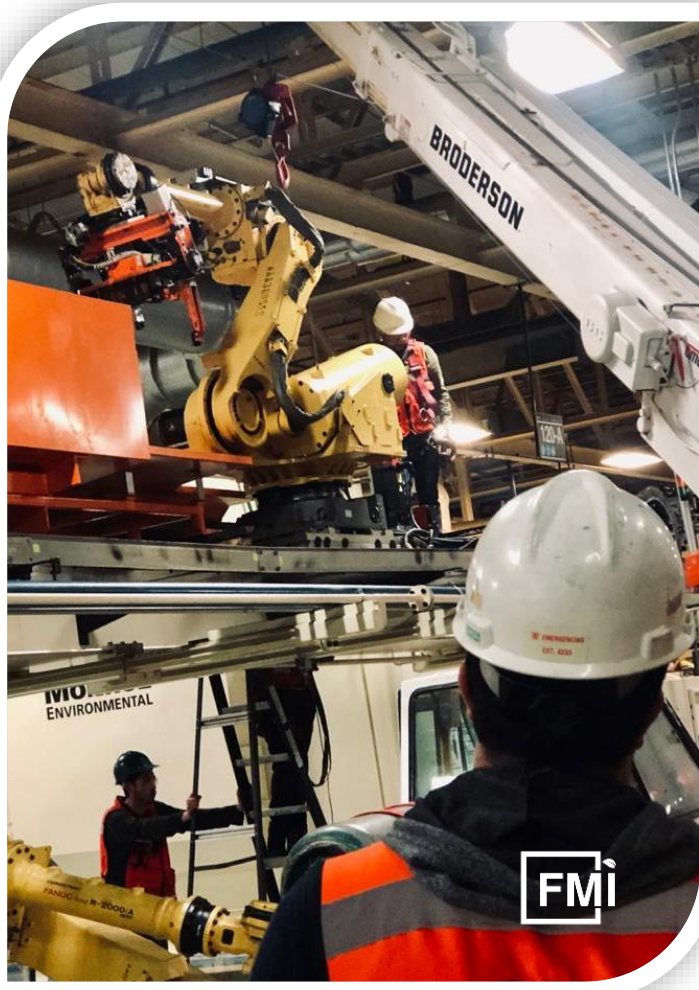

We offer updates, maintenance and improvements for your robotic integrated processes. Our service tech team and our project management system, makes the most reliable experience to keep your line running at optimal conditions.

- Program backups
- Teaching and mastering
- Basic maintenance programs
- Lubrication
- Servos replacement
- Transmission replacement
- Installation
- Programming
- PLC integration
- Artificial vision



*Passion for better life*

 <https://tspgmexico.com>

 [hola@tspgmexico.com](mailto:hola@tspgmexico.com)

 +52 (844) 246 7962  
+52 (81) 1050 7251

 Calle Tercera #334  
Parque industrial Colosio  
Saltillo, Coah. México 25298

